

**Earth Ventures Mission-3**  
**ANNOUNCEMENT OF OPPORTUNITY**  
**Expendable Launch Vehicle Launch Services Program Information Summary**

**AO-Provided NASA Launch Services Ground Rules/Policy**

This document provides additional information on the Announcement of Opportunity (AO)-Provided Expendable Launch Vehicle (ELV) Launch Services. This launch service will be provided by NASA and procured and managed by the NASA Launch Services Program (LSP) using government contracts.

Under the provisions of the NASA contract, the launch service includes the launch vehicle (LV) and associated standard services, non-standard services (mission unique options), engineering and analysis, and minimum performance standards. LSP also provides technical management of the launch service, attains technical insight into the LV production/test (commensurate with a Class D mission), coordinates and approves mission-specific integration activities, provides mission unique LV hardware/software development, provides payload-processing accommodations, and manages the launch campaign/countdown.

At the appropriate time following mission selection, LSP, using the appropriate contracting mechanism, will competitively select a launch service provider and award a launch service contract for the mission based on customer requirements. The contract will be awarded to the Contractor that provides the best value in launch services to meet the Government's requirements based on technical capability/risk, reasonableness of proposed price, and past performance. Accordingly, assumption of a specific launch vehicle configuration as part of the AO proposal will not guarantee that the proposed LV configuration will be selected unless there is firm technical rationale for sole source. Any such rationale should be clearly identified and explained in the proposal.

All NASA-procured launch services are to be consistent with NASA Policy Directive (NPD) 8610.7D, Launch Services Risk Mitigation Policy for NASA-Owned and/or NASA-Sponsored Payloads/Missions. Commercial launch services acquired by NASA will be managed in accordance with NPD 8610.23C, Launch Vehicle Technical Oversight Policy and NPD 8610.24C, Launch Services Program Pre-Launch Readiness Reviews (or NASA participation in launch service provider's commercial readiness process). These NPD's can be accessed through the URLs:

<https://nodis3.gsfc.nasa.gov/displayDir.cfm?t=NPD&c=8610&s=7D>

<https://nodis3.gsfc.nasa.gov/displayDir.cfm?t=NPD&c=8610&s=23C>

<https://nodis3.gsfc.nasa.gov/displayDir.cfm?t=NPD&c=8610&s=24C>

**Launch Vehicle Information/Configuration/Performance**

For a AO-Provided ELV Launch Services, the proposal must design for the enveloping launch vehicle characteristics and capabilities provided in Attachment 1. Figure 1 depicts representative nominal performance to various circular orbits. Vehicle injection dispersion capabilities will determine the accuracy of targeting these orbits. Attachment 1 Figure 2

depicts the constraining payload fairing static envelope that would ensure compatibility across the range of potential launch vehicles currently expected to be available under the baseline launch service.

The LSP has developed a performance website for vehicles currently on contract to NASA. This website contains information relevant to NASA-procured launch services. This planning tool can be found at the web address: <http://elvperf.ksc.nasa.gov/Pages/Default.aspx/> Access to this site is available to anyone with an Internet connection and is generally available at any time. For questions, utilize the point(s) of contact listed in this document.

### **Launch Service Costs**

NASA will be responsible for the launch services. Services provided under the AO-provided launch service are:

- the launch vehicle, engineering, analysis, and minimum performance standards and services provided by the NASA contract in place at the time of LV selection;
- mission integration;
- launch site payload processing;
- range safety support;
- down range telemetry support (launch vehicle data only);
- nominal allocation for non-standard/mission unique launch vehicle modifications/services – items typically necessary to customize the basic vehicle hardware to meet spacecraft driven requirements. See Attachment 2 for items included in Earth Venture Mission - 3 AO.

The “baseline” launch service for this AO is based upon a small-class vehicle.

The cost does not include funding for PI/payload caused launch delays.

### **Evaluation Form**

Attachment 3 shows a preliminary checklist to be used as a guide for the evaluators to assess the launch services. This checklist should provide a guide to the types of information that are expected to be contained in the proposals.

### **NASA LSP Point of Contact for Additional Information**

Additional information including performance quotes, mission integration inquiries, and costs for non-standard services may be obtained from the point of contact below. Otherwise questions must be directed as indicated in the AO.

**Garrett Skrobot**  
**Mission Manager**  
**NASA Launch Services Program**  
**Code VA-C**  
**Kennedy Space Center, FL 32899**  
**Phone: 321-867-5365**  
**Email: [garrett.l.skrobot@nasa.gov](mailto:garrett.l.skrobot@nasa.gov)**

# Attachment 1

## Launch Service Characteristics/Capabilities

### Performance Information:

Performance capabilities to a range of orbit altitudes/inclinations is available from multiple launch sites. Figure 1 depicts expected representative nominal performance to a common range of altitudes/inclinations (circular orbits). For mission specific information, utilize the LSP performance website and/or the point(s) of contact listed in this document. The LSP performance website may provide multiple vehicle solutions for a practical orbit, however not all vehicles are to be considered in this AO due to cost constraints. Please communicate with the point(s) of contact listed in this document for additional information.

### Performance Ground Rules:

- The LV performance available generally does not include impacts associated with orbital debris compliance; this must be evaluated on a mission-specific basis. Depending on the LV configuration, this could result in a significant performance impact to ensure full compliance with orbital debris policy.
- Guidance reserves have been allocated to account for 3-sigma flight performance.
- Vehicle-specific injection dispersion capabilities will determine the accuracy to which the orbit targets can be achieved.
- Performance is for baseline LV configuration; non-standard, mission-unique hardware will require additional assessment.
- A representative separation system is assumed, the mass of which is book-kept on the launch vehicle side.

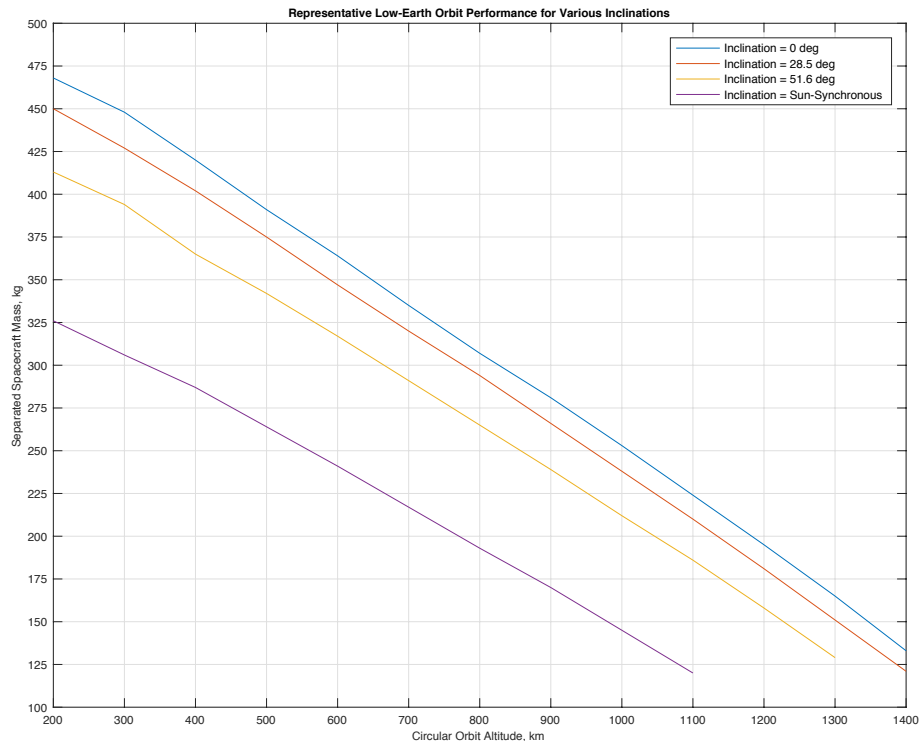
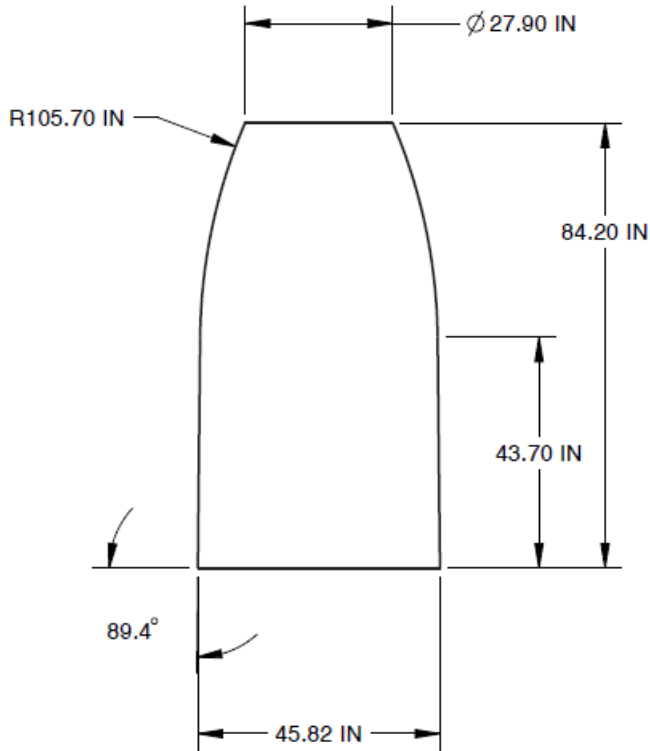

Figure 1: Constraining Performance Curves

**Payload Envelope:**

Figure 2 below shows the constraining static payload fairing envelope that will enable compatibility with all potential small-class launch vehicle configurations projected to meet the performance capability shown in Figure 1.



**Figure 2**  
**Static Fairing Envelope (in.)**

- Proposals should include sufficient S/C dimensions to validate fit within this PLF static envelope, including any close approaches.

**Figures 3.x Enveloping Environments (Loads, CG, Acoustics, Shock)**

3.a CG Load Factors

Envelope	
Lateral (g's)	Axial (g's)
1.7	14
3.6	4.7
3.7	1
6.75	0.5
6.75	-0.5
3.7	-1
3.15	-1.2
3	-1.5
2	-1.5
2	-4
-2	-4
-2	-1.5
-3	-1.5
-3.15	-1.2
-3.7	-1
-6.75	-0.5
-6.75	0.5
-3.7	1
-3.6	4.7
-1.7	14
1.7	14

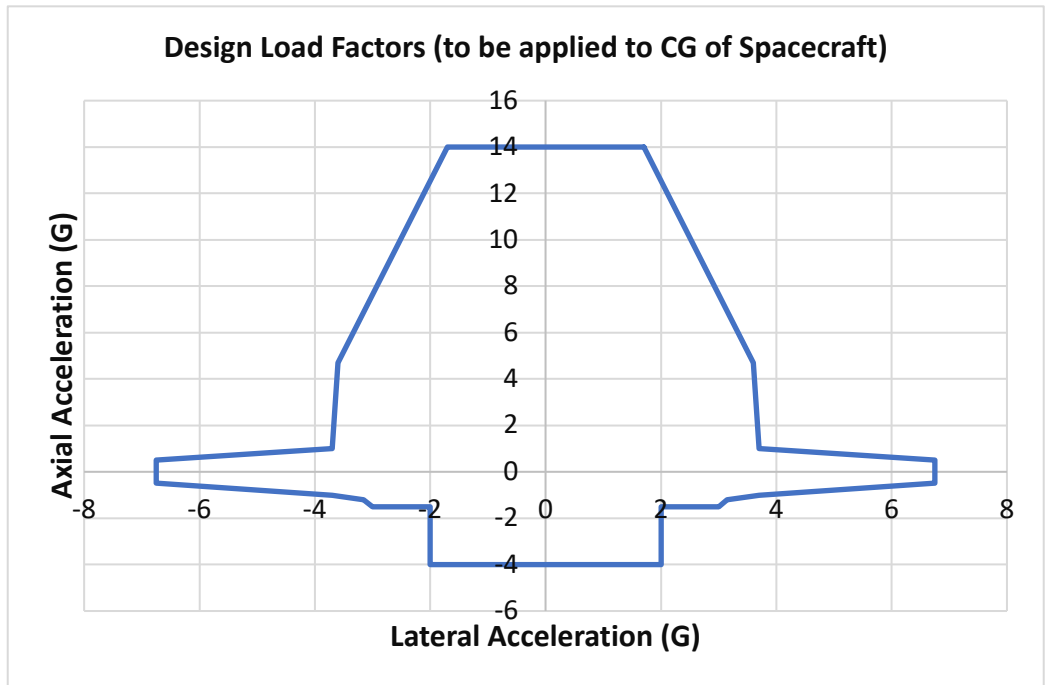

3.b Equivalent Sine MPE Level at Spacecraft Interface (Q=10)

Envelope			
Frequency (Hz)	Axial	Frequency (Hz)	Lateral
5	0.5	5	0.5
20	0.8	85	0.5
35	0.8	100	0.6
65	1.85		
75	1.85		
100	1.2		

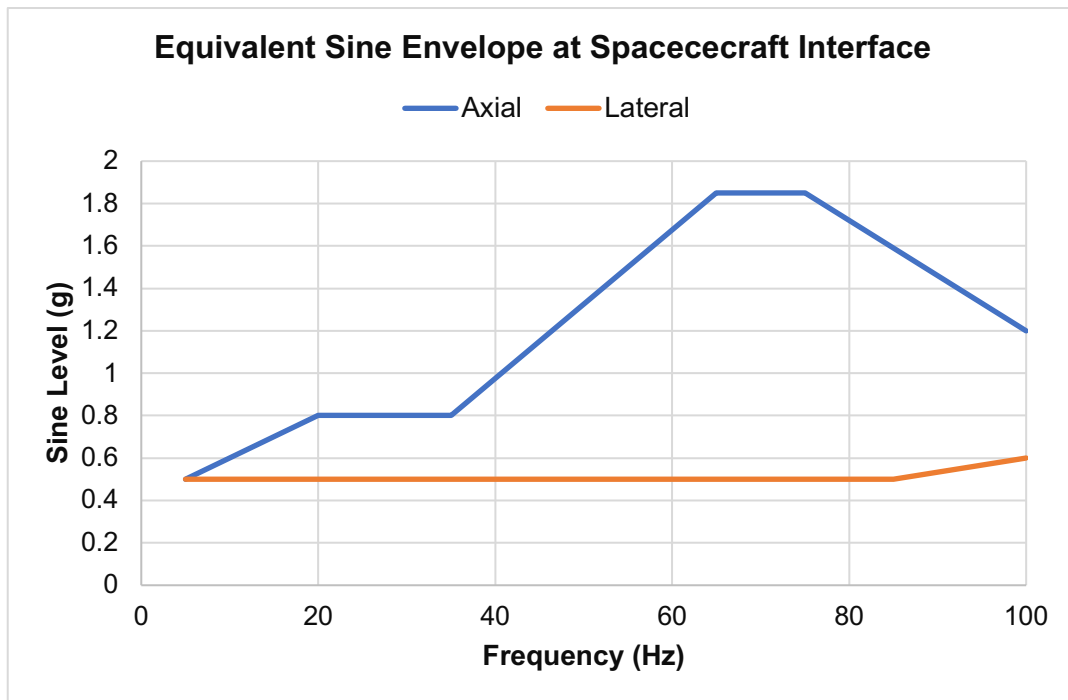

### 3.c Random MPE Levels at Spacecraft Interface

Suggested Interface Random Vibe Design Envelope	
Frequency (Hz)	PSD (G <sup>2</sup> /Hz)
20	0.0044
36	0.0044
40	0.008
70	0.008
83	0.0044
100	0.0044
300	0.01
700	0.01
800	0.03
925	0.03
2000	0.00644

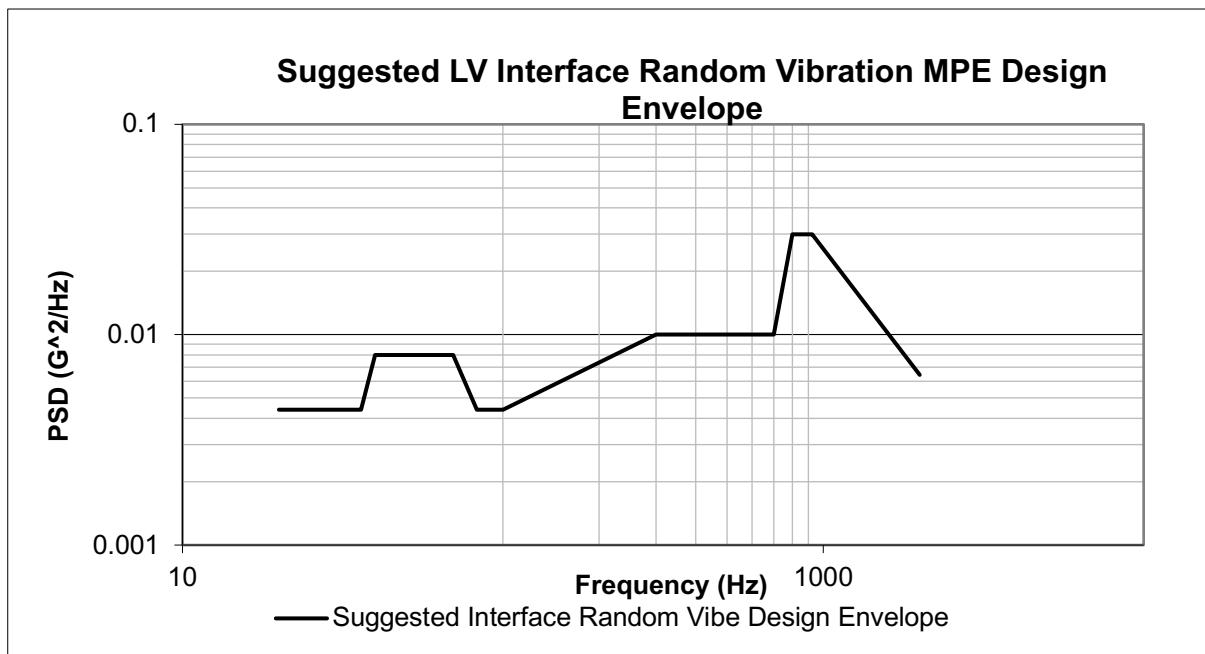

### 3.d Acoustics

<b>Suggested Acoustics Design Envelope</b>	
<b>Frequency (Hz)</b>	<b>SPL (dB)</b>
12.5	108
15.75	108
20	108
25	118
31	119.75
40	120
50	120
63	120
80	119.8
100	120.5
125	121.5
160	122
200	121.5
250	120.5
315	119
400	117
500	115
630	115
800	119
1000	114
1250	114
1600	111.5
2000	111
2500	108
3150	106.5
4000	106
5000	102
6300	101
8000	100
10000	99



### Payload Acoustics MPE - 1/3 Octave Band SPL

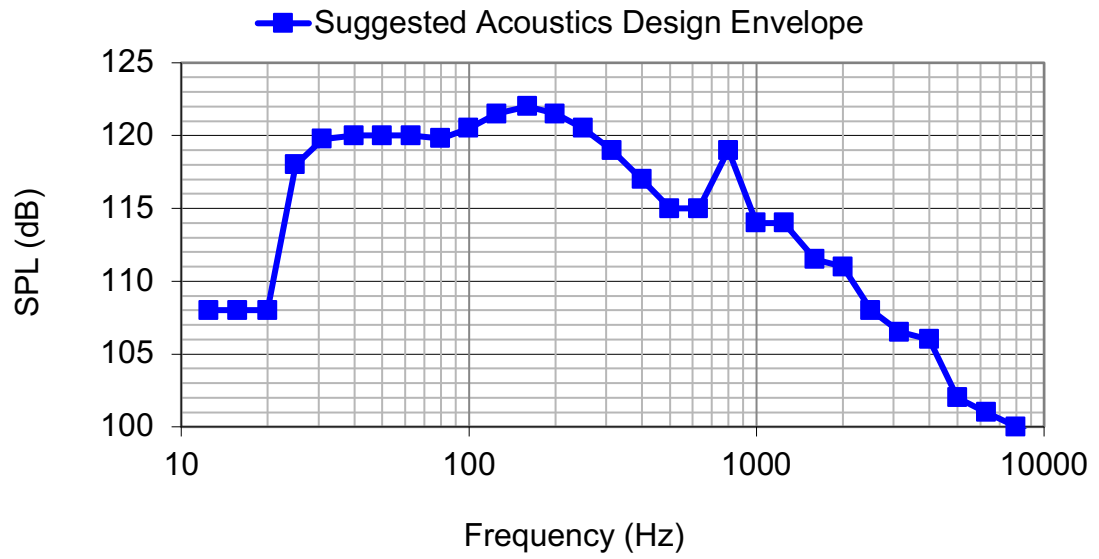

### 3.e Shock MPE Levels at Spacecraft Interface

Suggested Interface Shock Design Envelope	
Hz	SRS (g-peak)
100	100
1000	3500
10000	3500

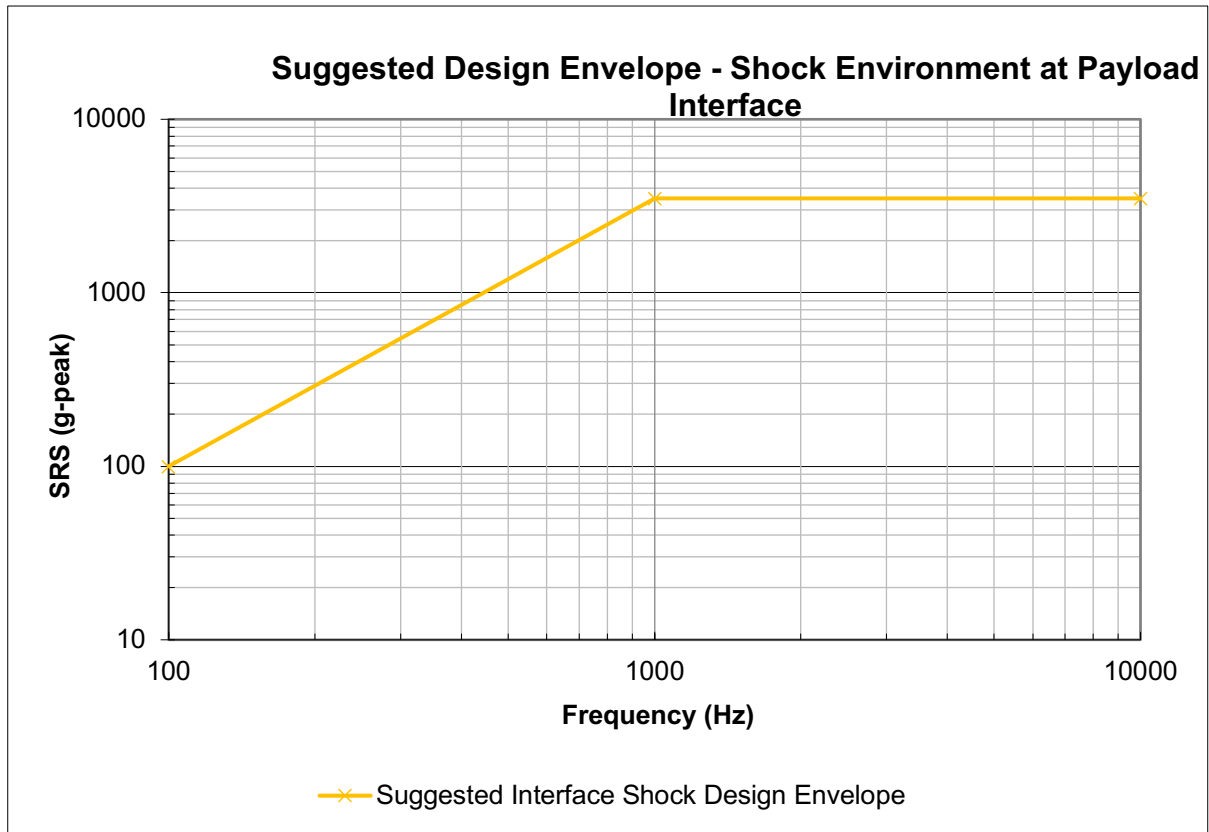

## **Attachment 2**

### **NASA-LSP Standard Launch Services**

This list provides an overview of the standard services that the spacecraft customer will receive with an NASA/LSP-Provided Primary Launch Service.

#### **Integrated Services:**

- Range support and services
- Payload processing facility and support
- Contractor Engineering support
- Base Support contractors
- Logistics
- Hazardous support

#### **Launch Vehicle:**

- Launch vehicle that meets customer's performance needs
- Payload Fairing with approximately 2 access doors
- Standard LV-provided Payload Separation System
- Standard Payload Adapter
- Standard Test Payload adapter availability
- Single-Spacecraft Collision/Contamination Avoidance Maneuver (CCAM) capability if needed
- Electrical interface connectors (approximately 3 sets)
- Mission Unique Reviews
- Readiness Reviews
- Risk Identification
- Launch Vehicle insight and approval per NPD 8610.23
- Mission integration management & engineering support
- Launch campaign management
- Down range telemetry assets for LV data

#### **Nominal Non-Standard/Mission Unique Services included**

- Mission Unique payload isolation system
- T-0 GN2 or pure air Purge
- Class 100K integration environment

The following list provides examples, but not limited to, non-standard/mission unique services that are not included in this AO's NASA-provided launch service, and whose cost would need to be included as part of the Principal Investigator Managed Mission Cost.

- Spacecraft to Launch Vehicle integration @ alternate launch sites
- Custom Payload Adapters
- Auxiliary Propulsion for target orbit achievement
- Spacecraft Spin/De-spin capability for separation (if required)
- Deployable Telemetry Tracking Assets for multiple spacecraft missions
- LV mods/analyses for non-separating interface with multiple SC deployments
- Class 10K integration environment

**Attachment 3  
Evaluation Form  
Launch Services Program**

Proposal Name: \_\_\_\_\_

Proposal #: \_\_\_\_\_

Evaluator POC: \_\_\_\_\_

Phone: \_\_\_\_\_

Email: \_\_\_\_\_

---

**Launch Service Technical Evaluation:**

**Overall Assessment:** - Given the ground rules in the AO, is the proposed launch vehicle (LV) concept feasible for this application? (Yes or No)

Comments: \_\_\_\_\_

\_\_\_\_\_

**LV Performance:** Area of concern (Yes or No)

Proposed LV configuration: \_\_\_\_\_

Proposed Launch Date: \_\_\_\_\_

Launch Period (MM/DD/YYYY to MM/DD/YYYY): \_\_\_\_/\_\_\_\_/\_\_\_\_ to \_\_\_\_/\_\_\_\_/\_\_\_\_

Launch Window (On any given day of the launch period Minutes:Seconds): \_\_\_\_ : \_\_\_\_

Orbit requirements: Apogee: \_\_\_\_\_ km Perigee: \_\_\_\_\_ km Inclination: \_\_\_\_\_ deg.

High Energy requirements: C3: \_\_\_\_\_ km<sup>2</sup>/sec<sup>2</sup> DLA: \_\_\_\_\_ deg RLA: \_\_\_\_\_ deg

Proposed LV Performance: \_\_\_\_\_

Mass (including reserves) Dry Mass: \_\_\_\_\_ kg Wet Mass: \_\_\_\_\_ kg

Dry Mass Margin: \_\_\_\_\_ kg \_\_\_\_\_ %

Wet Mass Margin \_\_\_\_\_ kg \_\_\_\_\_ %

Formulas:

Mass Margin kg = LV Performance – S/C Mass (including reserves)

Mass Margin % = [(Mass Margin kg)/ S/C Mass (including reserves) kg] X 100

LV Performance Comments/issues/concerns:

\_\_\_\_\_

\_\_\_\_\_

\_\_\_\_\_

**Launch Service Cost Assessment:** Area of concern (Yes or No)

Is there additional funding for any mission unique modifications/services? (Yes or No)

**LV Integration:** Area of concern (Yes or No)

Does the proposer have experience in LV integration? (Yes or No)

**LV to Spacecraft Interface:** Area of concern (Yes or No)

Proposed Payload Fairing (PLF) \_\_\_\_\_

Spacecraft (S/C) Dimensions: Radial: \_\_\_\_\_ m Height \_\_\_\_\_ m

Any intrusions outside of the PLF usable *static* volume? (Yes or No)

**Mechanical Interface:**

Standard Adaptor: \_\_\_\_\_ Custom Adaptor: \_\_\_\_\_

**Electrical Interface:**

Standard \_\_\_\_\_ Pin(s) Connector(s): (Yes or No)

**Mission Unique requirements:**

Instrument T-0 GN<sub>2</sub> Purge: (Yes or No)

T-0 S/C Battery Cooling: (Yes or No)

Planetary Protection Requirements: (Yes or No)

Contamination Control Requirements: PLF: (Yes or No) LV adapter: (Yes or No)

Cleanliness Level: \_\_\_\_\_ other: \_\_\_\_\_

**Unique Facility Requirements:** (Yes or No)

Pad: \_\_\_\_\_

S/C Processing Facility: \_\_\_\_\_

**S/C Environmental Test Plans**

Environmental Test Plan/Flow described: (Yes or No)

Test Levels provided: (Yes or No)

Test Schedule provided: (Yes or No)

Comments/issues/concerns: \_\_\_\_\_

**Spacecraft Schedule:** Area of concern (Yes or No)

**Adequate timing of:** Launch Service Integration Start Time: Yes or No)

S/C Environmental Test Program: (Yes or No)

Delivery of Verified S/C Model: (Yes or No)

S/C ship date: (Yes or No)

S/C to LV integrated Operations: (Yes or No)

**Missions with Radiological material** Area of concern (Yes or No)

List the Radiological Sources: \_\_\_\_\_

Are unique facilities required to store/process the Radiological Sources? (Yes or No)

Any LV modifications required for additional safety or Launch approval? (Yes or No)

**Non-NASA Launch Services** Area of concern (Yes or No)

Does proposal address the PI's approach to managing the commercial launch service? (Yes or No)

Is the proposal clear on the approach that the PI will utilize to ensure the adequacy of the technical work performed by the launch provider and to determine flight worthiness? (Yes or No)

Does the proposal identify elements of the launch service in which the PI has approval per the modified approach for class D in NPD 8610.23? (Yes or No)

Does the proposal identify elements of the launch service in which the PI will have insight per the modified approach for class D NPD 8610.23? (Yes or No)

Does the proposal clearly identify the approach that the PI will utilize to perform a Category 1 Certification of the Common Launch Vehicle Configuration (CLVC) per NPD 8610.7, or is the PI providing a CLVC already Category 1 or higher certified? (Yes or No)

Does the proposal address PI's responsibility to obtain NASA Flight Planning Board approval prior to acquisition of the launch service? (Yes or No)

Does the cost estimate account for the full launch service including mission unique costs, payload processing facility costs, delay penalties, spacecraft fueling costs, and identified risks? (Yes or No)

Indicate the type of launch vehicle payment schedule. Are all funds due up front or are payments made over the integration period? (Yes or No)

END OF DOCUMENT